

# HƯỚNG DẪN COPY CHỨNG MINH THƯ – ID CARD MÁY PHOTOCOPY **TOSHIBA**



**e-STUDIO**

## COPY CHỨNG MINH THƯ – ID CARD

- Chọn khay giấy là A4
- Chọn [ ZOOM ORG. → A4 ]

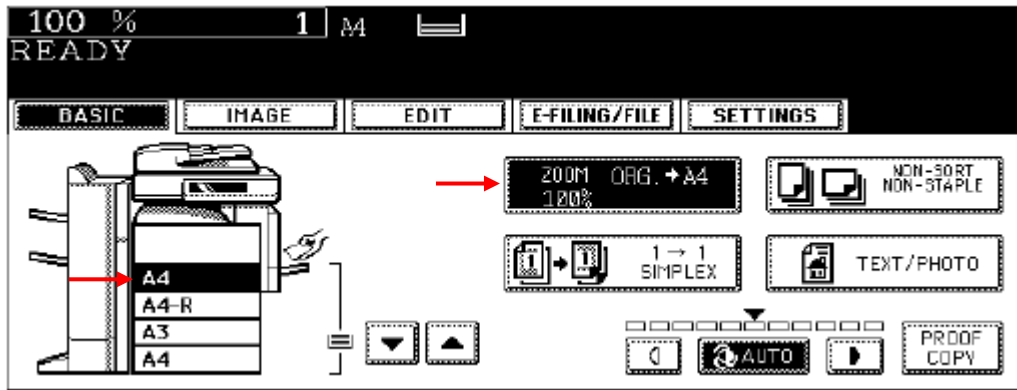

- Chọn [Original] là A5, [Copy] là A4
- Chọn [RETURN]

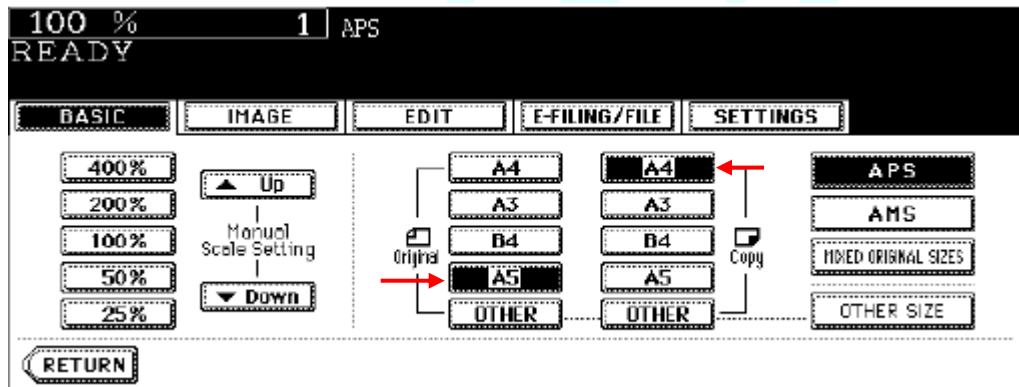

- Chọn [EDIT]
- Chọn [2IN1/4IN1]

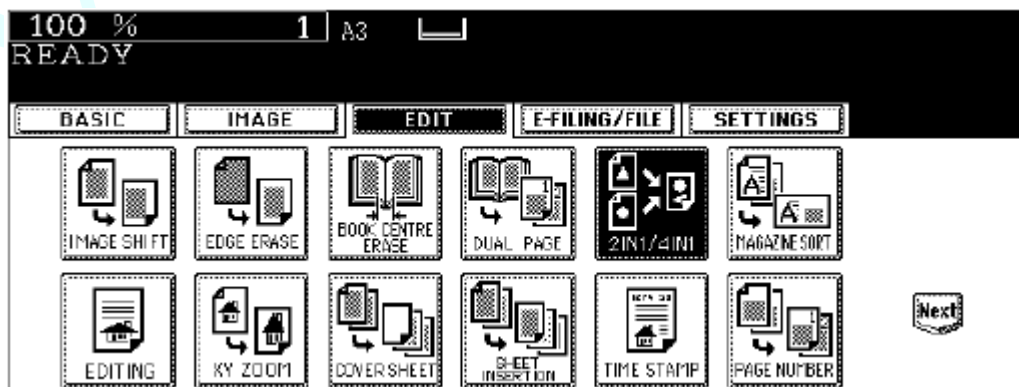

- Chọn [2IN1]

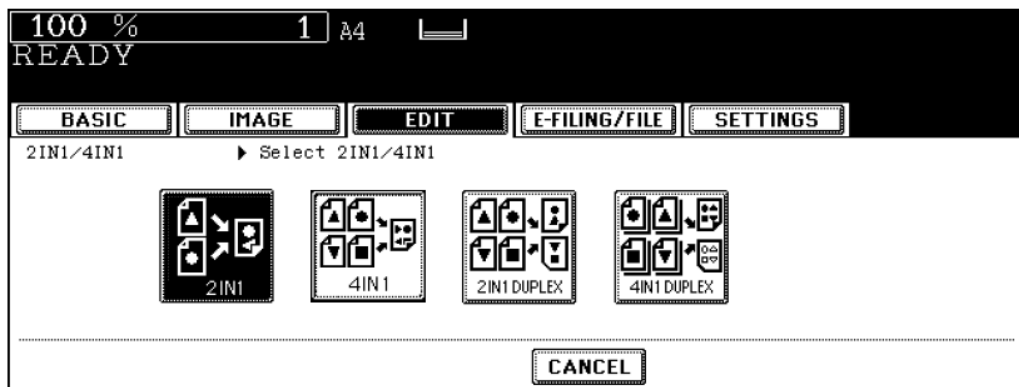

- Chọn [1 SIDE]

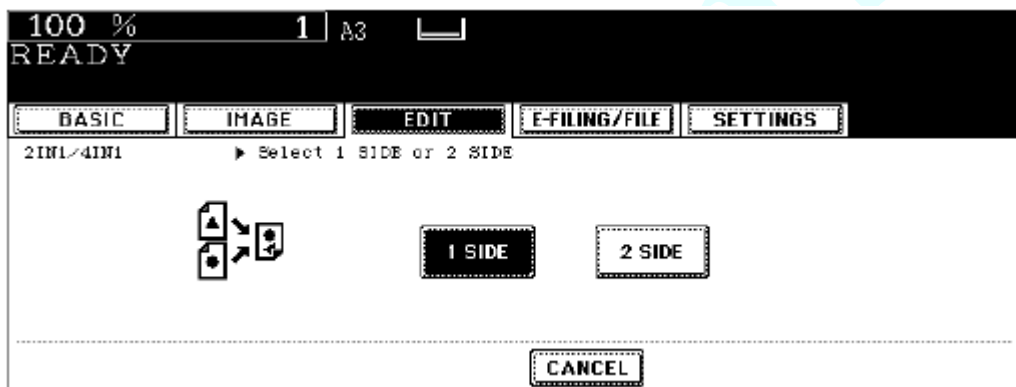

- Chọn [BASIC]

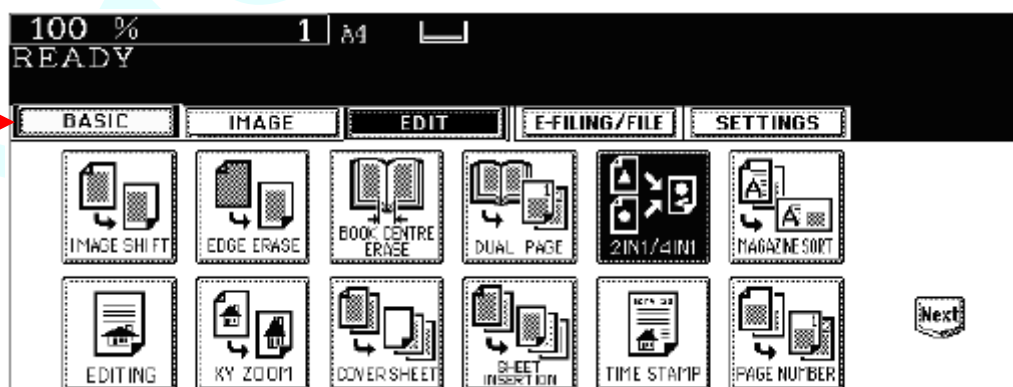

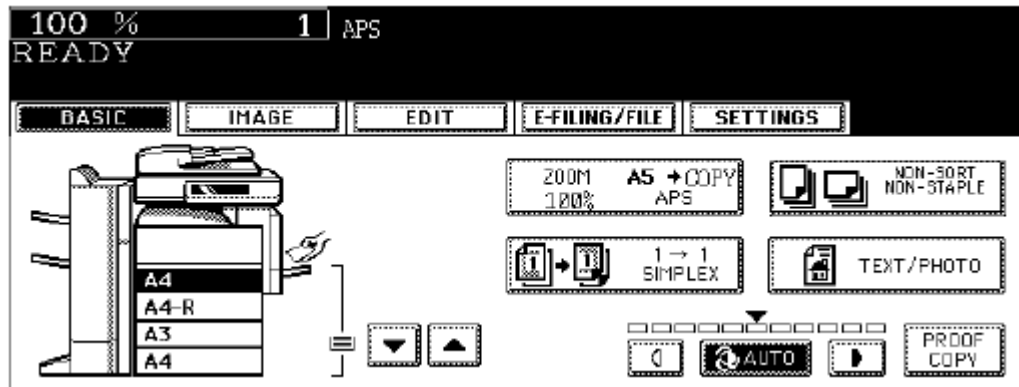

- Đặt và lật bản gốc theo chiều mũi tên
- \* Chú ý: đặt bản gốc “CMND” ở giữa khổ A5

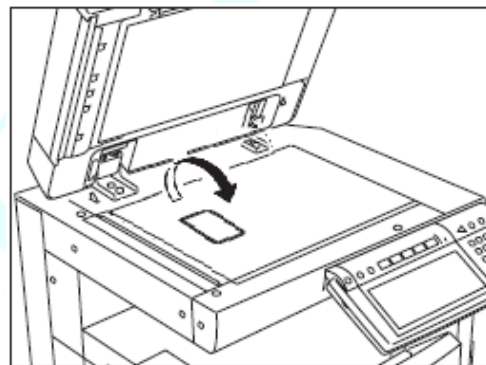

- Ấn [START] để bắt đầu

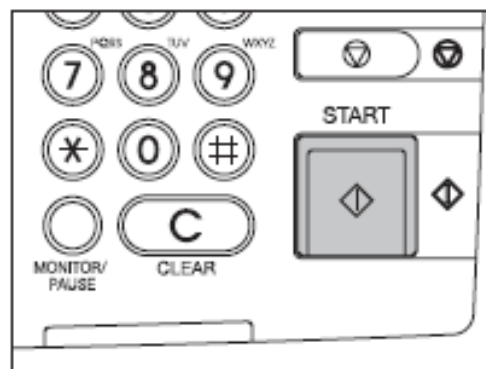

- Chúc quý khách thành công.